







LOCKS









SHEET METAL
1/8 TURN
PUSH
CAM

CAM LOCKS

Picture	Item No.	Key Changes	Master Key Option	Page
	DCY-34	2000	866 / 1 master key	331
	3800S	300	300 / 1 Master Key	331
	900	1 Million	2520 / 1 Master Key	332
	SN-711-8	1500	-	332
	NAL	5000	-	333
	NAL-S	100	-	333

PUSH LOCKS

Picture	Item No.	Key Changes	Master Key Option	Page
	2100M	12	-	334
	2110M	12	-	334
	2100B	12	-	335
	2110B	12	-	335
	2150B	24	-	336
	2160M	24	-	336
	6300	96	-	337

CABINET LOCKS

Picture	Item No.	Key Changes	Master Key Option	Page
	2200QL	300	170 / 1 Master Key	337

SHEET METAL CAM LOCK



DCY-34



- High security with special key design.
- Reversible key.
- 90 degree cam rotation
- Key is removable in locked position only. (Key works as a knob in unlocked position.)
- Universal direction - Cam direction changeable.
- 2,000 key changes available.
- Master key type available at surcharge. (Maximum 866 key changes per master key)

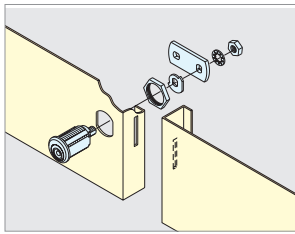

Installation

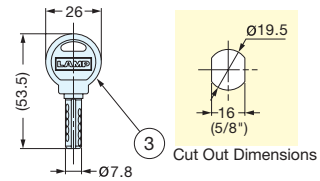
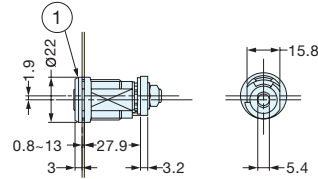
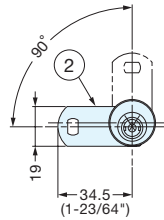

Cut Out Dimensions

Item No.	Key Changes	Keys Included	Weight (g)	Box (pcs)	Carton (pcs)
DCY-34	2000	2	101	-	-

No.	Part Name	Material	Finish
①	Body	Brass	Chrome
②	Cam	Copper	
③	Key	Brass	Nickel

SHEET METAL CAM LOCK



3800S

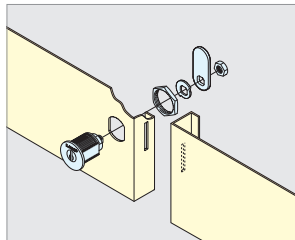

Installation

- High corrosion with stainless steel material in use.
- Reversible key.
- Key is removable in locked position only. (Key works as a knob in unlocked position.)
- Universal direction - Cam direction changeable.
- 300 key changes available.
- Master key type available at surcharge. (Maximum 300 key changes per master key)

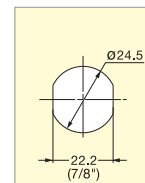
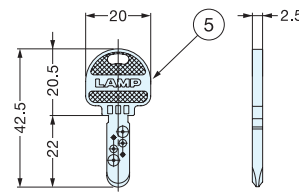
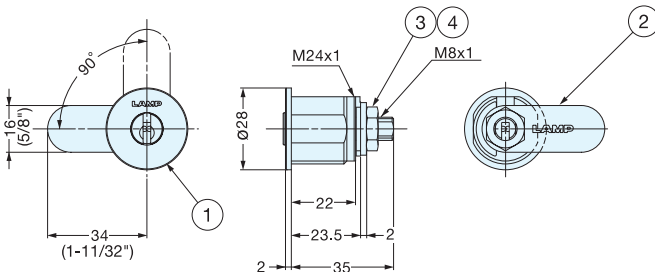

Cut Out Dimensions

Item No.	Key Changes	Keys Included	Weight (g)	Box (pcs)	Carton (pcs)
3800S	300	2	119	12	60

No.	Part Name	Material	Finish
①	Body	303 Stainless Steel	Satin
②	Cam	304 Stainless Steel	
③	Small Hex Nut	303 Stainless Steel	
④	Washer	304 Stainless Steel	
⑤	Key	Nickel Silver	-

SHEET METAL CAM LOCK

900

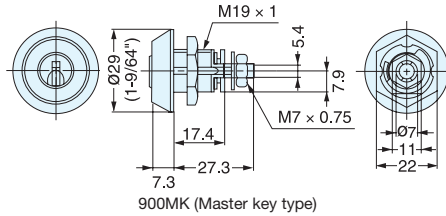
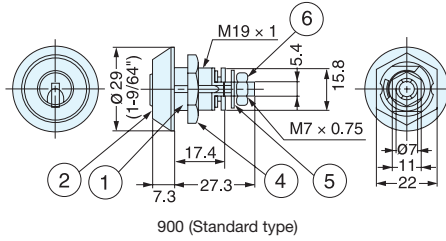

- Brass cylinder cam lock.
- Reversible key.
- 90 degree cam rotation.
- Key is removable in locked position only. (Key works as a knob in unlocked position.)
- 1 million key changes available.
- Master key type available at surcharge. (Maximum 2,520 key changes per master key.)

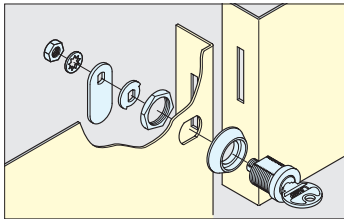
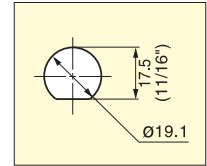
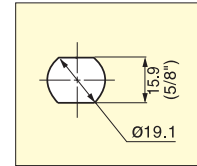

Installation

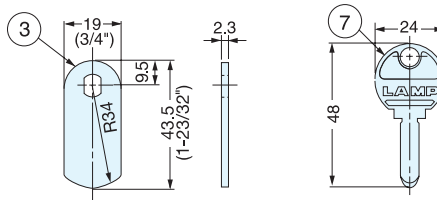

Item No.	Key Changes	Keys Included	Weight (g)	Box (pcs)	Carton (pcs)
900	1 million (2520/1 Master Key)	2	120	12	60
900MK (with Master key)					

No.	Part Name	Material	Finish
①	Body	Brass	Chrome
②	Ring		
③	Cam	Steel	Yellow Zinc Chromate
④	Hex Nut		Nickel
⑤	Washer		Yellow Zinc Chromate
⑥	Hex Nut	Brass	Nickel
⑦	Key		

SHEET METAL CAM LOCK

SN-711-8



- Brass cylinder cam lock.
- 90 degree cam rotation.
- Key is removable in locked position only.
- 1,500 key changes available.
- * Extreme pressure on key when in unlocked position may cause damage to the lock.

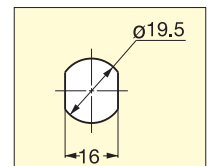
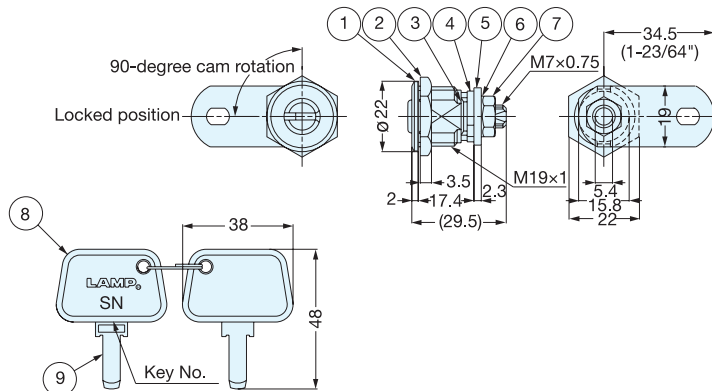

Item No.	Key Changes	Keys Included	Weight (g)	Box (pcs)	Carton (pcs)
SN-711-8	1500	2	77	50	150

No.	Part Name	Material	Finish/Color
①	Body	Brass	Chrome
②	Large Hex Nut	Steel	Yellow Zinc Chromate
③	Ring	304 Stainless Steel	Plain
④	Cam	Steel	Chromate
⑤	Plate		
⑥	Washer		
⑦	Small Hex Nut		
⑧	Cover	ABS	Black
⑨	Key	Brass	Nickel

SHEET METAL CAM LOCK

NAL

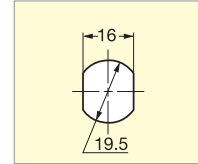
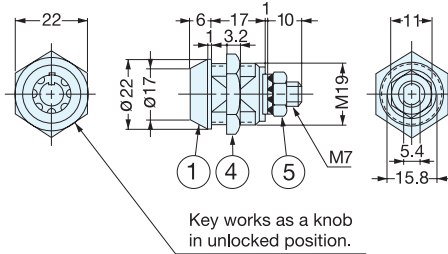

- Brass cylinder tubular cam lock.
- 90 degree cam rotation.
- Key is removable in locked position only. (Key can be used as knob in unlocked position.)
- Special order for different key configuration available upon request.
- 5,000 key changes available.

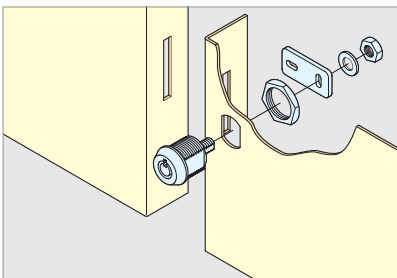

Installation

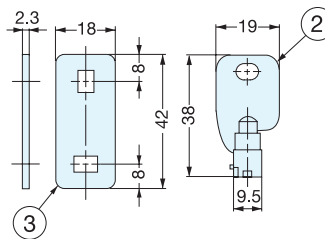

No.	Part Name	Material	Finish
①	Body	Brass	Chrome
②	Key	Steel	Nickel
③	Cam		Yellow Zinc Chromate
④	Hex Nut		
⑤	Hex Nut		

Item No.	Door Thickness	Cylinder Diameter	Key Changes	Keys Included	Weight (g)	Box (pcs)	Carton (pcs)
NAL	Less Than 10 (25/64")	19 (3/4") / Width 15.8 (5/8")	5000	2	55	100	300

SHEET METAL MINI CAM LOCK

NAL-S



- Mini zinc alloy cylinder cam lock for sheet metal doors.
- 90 degrees cam rotation.
- Cam is reversible.
- NAL-S-1: Key withdrawals in locked position only. (Key works as a knob in unlocked position.)
- NAL-S-2: Key withdrawals in both locked and unlocked positions.
- Master key type available upon request. (Special order)
- * Cam should be horizontal when locked, and should be pointing upwards when unlocked.
- * Not suitable for compression latch situation.
- * Pressure to cam may cause damage to cylinder.
- 100 key changes available.

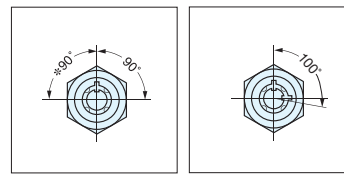
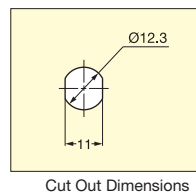

* Turn the cam (③) over to use NAL-S as a counterclockwise turn lock.

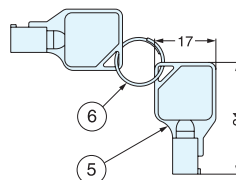
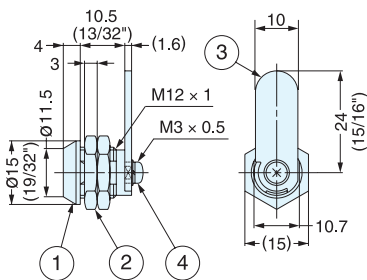

No.	Part Name	Material	Finish
①	Body	Zinc Alloy	Chrome
②	Hex Nut	Steel	Nickel
③	Cam		Zinc
④	Screw		
⑤	Key	Steel & Brass	Nickel
⑥	Key Ring	Steel	

Item No.	Number of Slot (s)	Cylinder Diameter	Key Changes	Keys Included	Weight (g)	Box (pcs)	Carton (pcs)
NAL-S-1	1	12 (15/32") / Width 10.7 (27/64")	100	2	25	100	500
NAL-S-2	2						

PUSH LOCK

2100M

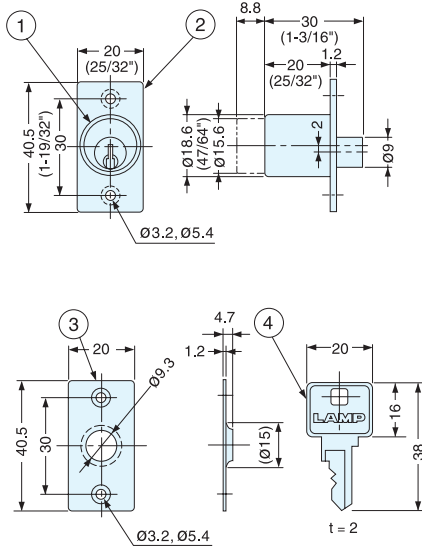

- Zinc alloy cylinder push lock for sliding doors.
- Push cylinder to lock.
- Cylinder Length: 20mm (25/32")
- Cylinder Diameter: 18.6mm (47/64")
- Master key NOT available.
- Keys can be shared with other 2100 series locks.
- 12 key changes available.

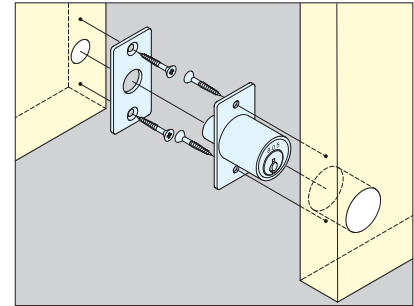

Installation

No.	Part Name	Material	Finish
①	Body	Zinc Alloy	Satin Nickel
②	Mounting Plate	Brass	Nickel
③	Counterplate		
④	Key		

Item No.	Door Thickness	Weight (g)	Box (pcs)	Carton (pcs)
2100M	20 (25/32")	60	12	240

PUSH LOCK

2110M

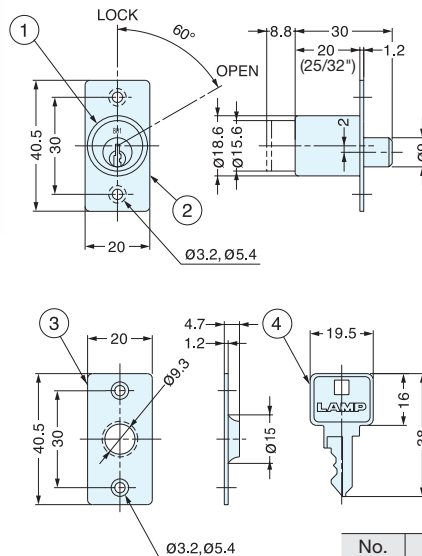

- Zinc alloy cylinder push lock for sliding doors.
- Key is required to lock and to unlock.
 - To Lock: Insert key and turn 60° clockwise.
 - Push-in the cylinder and turn the key 60° back.
- Key is removable in both locked and unlocked position.
- Cylinder Length: 20mm (25/32")
- Cylinder Diameter: 18.6mm (47/64")
- Master key NOT available.
- Keys can be shared with other 2100 series locks.
- 12 key changes available.

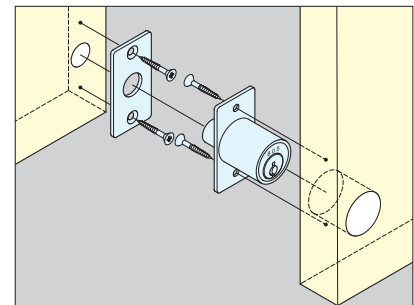

Installation

No.	Part Name	Material	Finish
①	Body	Zinc Alloy	Nickel
②	Mounting Plate	Brass	
③	Counterplate		
④	Key		

Item No.	Door Thickness	Weight (g)	Box (pcs)	Carton (pcs)
2110M	20 (25/32")	60	12	240

PUSH LOCK

2100B



- Zinc alloy cylinder push lock for metal-framed glass doors or sheet metal double sliding doors.
- Push cylinder to lock.
- Cylinder Diameter: 18.6mm (47/64")
- Keys can be shared with other 2100 series locks.
- 12 key changes available.

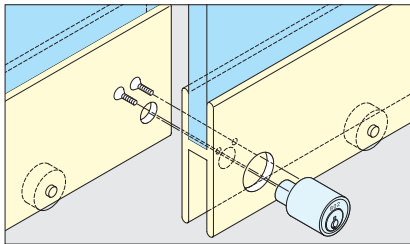
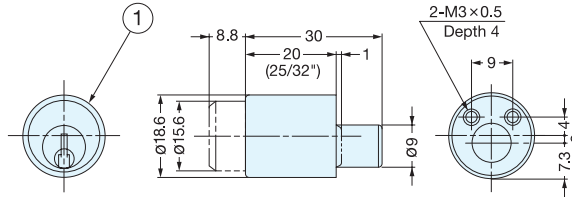

Installation

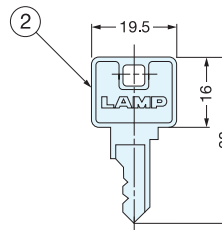

No.	Part Name	Material	Finish
①	Body	Zinc Alloy	Nickel
②	Key	Brass	

Item No.	Metal Frame Thickness	Cylinder Diameter	Key Changes	Keys Included	Weight (g)	Box (pcs)	Carton (pcs)
2100B	20 (25/32")	18.6 (47/64")	12	2	50	40	400

PUSH LOCK

2110B



- Zinc alloy cylinder push lock for metal-framed glass doors or sheet metal double sliding doors.
- Key is required to lock and to unlock.
- To Lock: Insert key and turn 60° clockwise. Push-in the cylinder and turn the key 60° back.
- Cylinder Diameter: 18.6mm (47/64")
- Keys can be shared with other 2100 series locks.
- 12 key changes available.

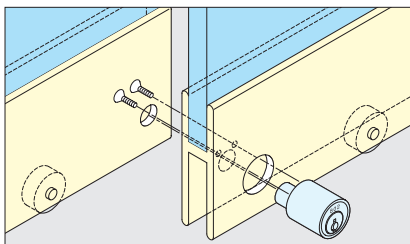
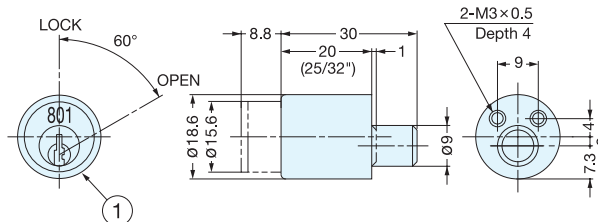

Installation

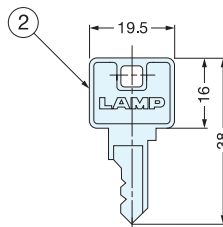

No.	Part Name	Material	Finish
①	Body	Zinc Alloy	Nickel
②	Key	Brass	

Item No.	Metal Frame Thickness	Cylinder Diameter	Key Changes	Keys Included	Weight (g)	Box (pcs)	Carton (pcs)
2110B	20 (25/32")	18.6 (47/64")	12	2	50	40	400

PUSH LOCK

2150B



- Zinc alloy cylinder push lock for metal-framed glass door or sheet metal double sliding doors.
- Push cylinder to lock.
- Cylinder Diameter: 18.6mm (47/64")
- Master key NOT available.
- 24 key changes available.

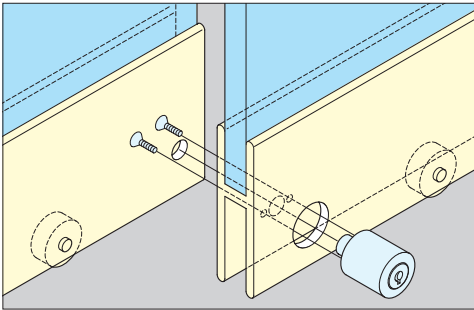
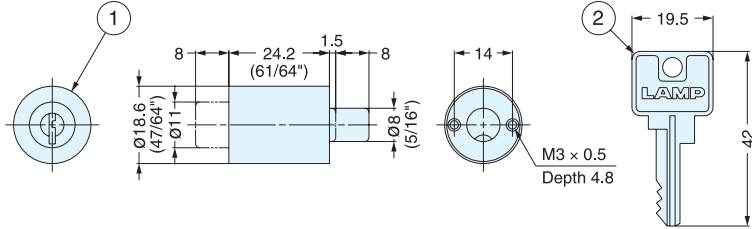

Installation

Item No.	Metal Frame Thickness	Weight (g)	Box (pcs)	Carton (pcs)
2150B	24(15/16")	50	24	240

No.	Part Name	Material	Finish
①	Body	Zinc Alloy	Nickel
②	Key	Brass	

PUSH LOCK

2160M



- Zinc alloy cylinder push lock for wooden doors.
- Key is required to lock and to unlock.
- Cylinder Diameter: 18.6mm (47/64")
- Master key NOT available.
- 24 key changes available.

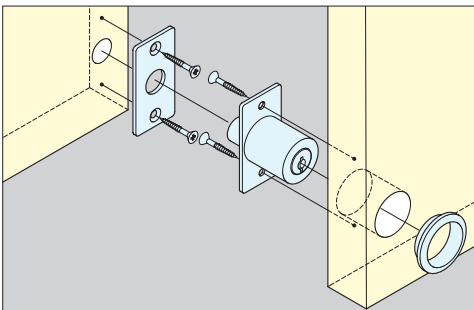
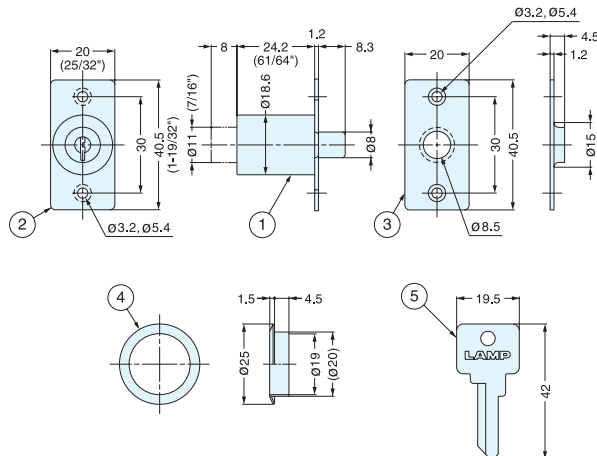

Installation

Item No.	Door Thickness	Weight (g)	Box (pcs)	Carton (pcs)
2160M	24 (15/16")	50	24	240

No.	Part Name	Material	Finish
①	Cylinder	Zinc Alloy	Nickel
②	Plate	Brass	
③	Counterplate		
④	Ring		
⑤	Key		

PUSH LOCK

6300



- Zinc alloy cylinder push lock for metal-framed glass doors.
- Easy installation. Only 10mm hole required on door.
- Cylinder Diameter: 17.6mm (11/16")
- Bolt Length: 25mm (63/64")
- Bolt Diameter: 9.8mm (25/64")
- 96 key changes.
- Master key NOT available.
- For material thickness is 1.2mm.

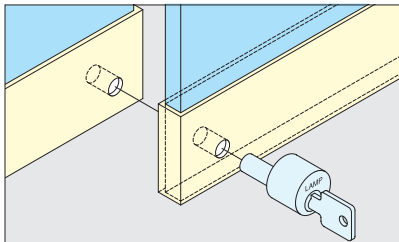

Installation

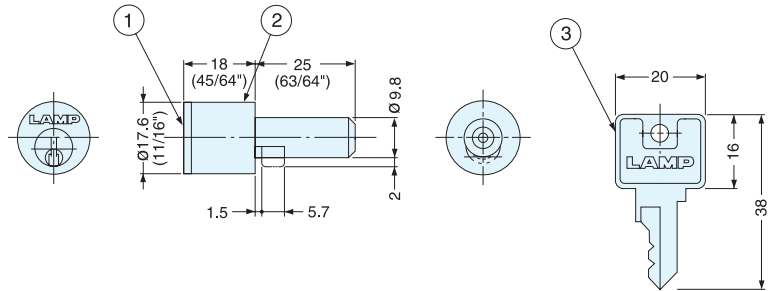

No.	Part Name	Material	Finish
①	Body	Zinc Alloy	Satin Nickel
②	Cover	Brass	Nickel
③	Key		

Item No.	Metal Frame Thickness	Cylinder Diameter	Key Changes	Keys Included	Weight (g)	Box (pcs)	Carton (pcs)
6300	19 (3/4")	17.6 (11/16")	96	2	50	24	240

CABINET LOCK (W/INDICATOR)



2200QL



- Only 1/8 turn is needed to unlock/lock the door.
- Key automatically returns to original position making it easy to remove the key.
- With indicator.
- 300 key change available.
- Master key type available at surcharge (Maximum 170 key changes per master key)

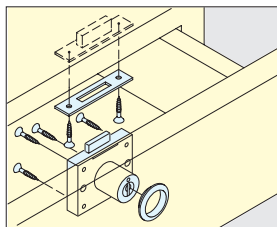

Installation for clawer

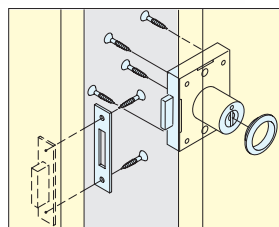

Installation for high - hand door

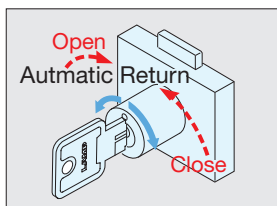
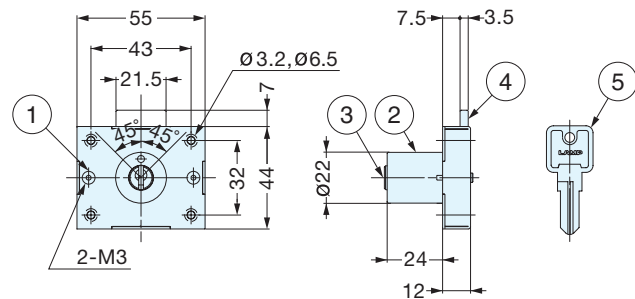

Operation

Item No.	Door Thickness	Weight (g)	Box (pcs)	Carton (pcs)
2200QL-24	24 (15/16")	208	12	60

No.	Part Name	Material	Finish
①	Body	304 Stainless Steel	-
②	Cylinder (Outer)	Brass	Chrome
③	Cylinder (Inner)	Zinc Alloy	
④	Dead Bolt		Brass
⑤	Key		