



Standard and Quick-Fitting Grommets

SR 1700/1701

Standard Grommets

SR 1700 Black PVC

- Protect wires and cables passing through panels

SR 1701 Black Thermoplastic Rubber

- Resist oils and greases
- Withstand temperatures from -40°C to +135°C

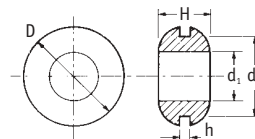

Part Number		Dimensions (mm)					Std Pack Qty
SR 1700 PVC	SR 1701 TPR	D	d ₁	d ₂	h	H	
11177	15057	8.0	2.8	4.8	0.8	4.8	10000
11026	15058	8.0	3.2	4.8	1.6	6.4	10000
15515	-	8.8	3.2	6.0	1.2	4.0	10000
10629*	15060	9.5	4.0	6.4	0.8	4.0	10000
11333	15059	9.5	4.0	6.4	1.6	6.3	10000
11402*	15062	9.5	4.0	6.4	3.0	8.0	10000
10280*	15061	9.5	4.8	6.4	1.6	7.0	10000
12603	-	9.5	4.8	6.4	1.6	7.0	10000
15505	-	11.1	5.6	7.9	1.2	4.0	10000
15501	-	11.1	5.6	7.9	1.6	6.4	10000
10117	-	11.0	3.0	8.0	3.0	8.0	10000
10489	15064	11.0	4.8	8.0	0.8	4.8	10000
11105	15065	11.0	5.5	8.0	1.6	5.5	10000
10597*	-	11.0	5.5	8.0	1.6	5.5	10000
10518	15067	12.5	4.8	9.5	1.6	6.8	10000
11178	15068	14.2	6.4	9.5	2.4	7.0	10000
11303	-	14.2	6.4	9.5	1.6	5.0	10000
10885*	15069	14.2	6.4	9.5	1.6	6.4	10000
11318	15072	13.8	7.0	9.5	1.2	4.0	10000
11272	15071	13.8	7.0	10.2	1.2	4.5	10000
10428	15073	14.2	8.0	9.5	1.6	4.8	10000
11107	15074	14.2	8.0	9.5	1.6	8.0	10000
15523	-	15.9	4.0	9.6	3.2	6.4	10000
40045	-	14.3	7.2	10.3	1.6	4.0	10000
40041	-	15.9	7.9	10.3	1.6	7.9	10000
11146	15075	14.2	8.0	11.0	1.6	4.8	10000
10744	15078	16.0	8.0	11.0	1.6	6.4	10000
11151	15076	14.2	8.0	11.0	1.6	8.0	10000
15524	-	15.9	6.4	11.9	1.6	7.9	10000
15506	-	17.5	9.6	11.9	2.0	6.8	10000
10605	15079	16.0	6.4	12.5	1.6	8.0	10000

* Black PVC grade VX321 Shore A 43.

Over 500 grommets in the full range. Popular sizes can be supplied in smaller boxed quantities for wholesalers; please contact our sales office for more details.

Part Number		Dimensions (mm)					Std Pack Qty
SR 1700 PVC	SR 1701 TPR	D	d ₁	d ₂	h	H	
10646	15080	16.0	8.0	12.5	1.6	6.4	10000
10770	15081	16.0	8.0	12.5	3.0	8.0	10000
11019	-	19.0	9.5	12.5	1.6	6.4	10000
10644	15084	17.0	9.5	12.5	1.6	7.0	10000
10911	15083	17.0	9.5	12.5	3.0	8.8	10000
10881	15086	19.0	11.0	12.5	1.6	6.4	10000
15508	-	19.0	9.6	13.5	3.2	9.6	10000
40042	-	23.0	9.6	13.5	4.0	8.8	5000
10592	-	19.0	9.5	14.2	1.6	6.4	10000
10281	15087	19.0	11.0	14.2	1.6	6.4	10000
15528	-	19.0	11.1	15.9	0.8	9.5	10000
40010**	-	20.6	12.7	15.9	1.2	5.0	10000
10738	15089	20.5	12.5	16.0	1.2	7.0	10000
10628	15090	22.0	12.5	17.5	1.6	6.4	8000
10512	-	22.0	14.2	17.5	1.6	4.8	10000
11029	15096	25.5	12.5	19.0	1.6	6.4	5000
40047	-	25.4	11.1	19.0	4.8	9.5	8000
15500	-	25.4	12.0	19.0	1.6	7.9	8000
11326	-	22.0	16.0	19.0	1.6	5.5	10000
10293	15093	24.0	16.0	19.0	1.6	6.0	7000
10215	-	24.0	16.0	19.0	1.6	4.8	10000
30007	15095	24.0	16.0	20.0	1.6	7.5	7000
11181	-	25.5	12.5	20.0	1.6	6.4	5000
11025	15098	27.0	16.0	20.5	1.2	8.0	4000
11213	-	31.4	18.5	25.2	1.2	7.5	4000
10487	15099	31.4	18.5	25.2	1.6	8.0	4000
10419	15101	30.0	22.0	25.5	1.6	8.0	4000
15514**	-	44.4	25.4	30.6	3.2	9.9	1000
11208	-	44.5	25.5	32.0	0.8	6.4	2000
11214	15102	38.0	24.9	31.0	1.6	7.8	2000
10446	15105	46.0	32.0	38.0	1.6	10.5	1000
10261	15104	46.0	32.0	38.0	3.0	11.0	1000
11072	15106	60.0	45.0	50.0	1.6	10.0	500

** Curved internal shoulders.

SR 1702

Quick-Fit Grommets

Black PVC

- Snap neatly and quickly into position
- Black thermoplastic rubber option for high temperatures
- Low-density polyethylene option for extra rigidity

Part Number			Dimensions (mm)		Std Pack Qty
h (Panel Thickness)			d ₁	d ₂	
1.5mm	2.0mm	3.0mm			
16200	16210	16220	6.0	10.0	10000
16201	16211	16221	7.0	11.0	10000
16202	16212	16222	8.0	12.0	10000
16203	16213	16223	10.0	14.0	10000
16204	16214	16224	12.0	16.0	10000
16205	16215	16225	14.0	18.0	10000
16206	16216	16226	16.0	20.0	4000
16207	16217	16227	18.0	22.0	4000
16208	16218	16228	22.0	26.0	4000
16209	16219	16229	24.0	28.0	2000

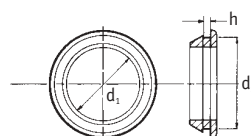



Please request a free sample to evaluate the suitability of a product for your application.



Grommets, Grommet Sleeves and Universal Bushes

SR 1705

Diaphragm Grommets

Black PVC

- Thin central film can be pierced to allow a range of different-sized wires to pass through

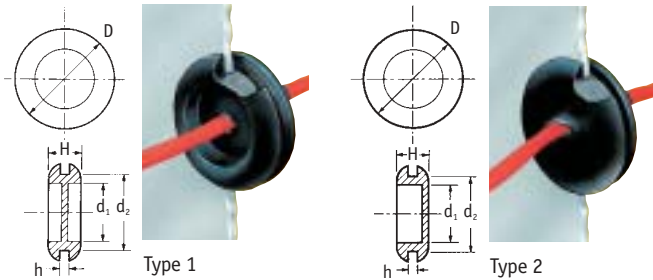

Part Number	Type	Dimensions (mm)					Std Pack Qty
		D	d ₁	d ₂	h	H	
19426	1	19.0	11.0	16.0	1.5	5.8	10000
19427	1	21.5	12.5	16.0	2.4	8.0	5000
19428	1	25.5	15.5	19.0	1.5	8.0	5000
15512	1	25.4	15.9	19.0	2.0	7.9	5000
10134	1	25.5	15.5	19.0	2.4	8.8	5000
19429	1	25.5	15.5	19.0	3.0	9.5	5000
10187	1	25.5	15.5	20.0	1.5	8.0	5000
10806	1	36.5	19.0	25.5	2.4	8.4	2000
19430	1	38.0	25.5	32.0	2.4	8.0	2000
19431	1	38.0	25.5	32.0	4.0	9.5	1000
19432	2	12.7	6.4	9.9	1.5	6.7	10000
19433	2	15.7	9.5	12.5	1.5	6.4	10000
19434	2	17.5	8.0	11.0	1.5	8.0	10000
19435	2	19.0	11.0	16.0	1.5	8.0	5000
19436	2	25.5	18.8	22.0	1.5	8.0	4000
19437	2	25.5	16.0	19.0	1.5	7.0	4000
19438	2	25.5	16.0	20.0	1.5	7.0	4000
19439	2	30.0	20.5	25.5	1.5	8.0	4000
19442*	2	49.0	31.0	42.0	2.4	10.1	1000

* TPR

SR 1710

Grommet Sleeves

Black PVC

- Provide extra support and protection for cables and wires passing through panels

Part Number	Dimensions (mm)								Std Pack Qty
	D	d ₂	d ₁	d ₅	h ₁	d ₄	d ₃	h ₂	
12461*	14.2	7.6	6.1	5.5	3.8	8.2	7.9	31.7	5000
60466	14.3	8.7	5.1	5.1	1.6	8.7	7.1	42.9	4000
50687	14.2	9.5	6.4	6.4	2.4	9.5	7.9	14.3	10000
12468	14.0	9.5	6.4	6.4	2.6	9.5	7.9	23.0	10000

* Features a flange on the narrow end.

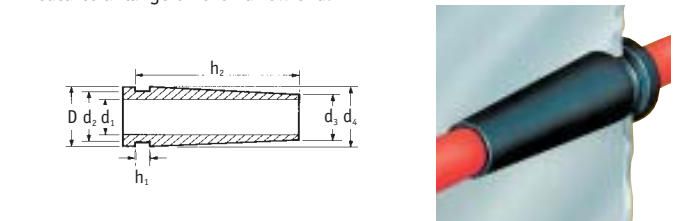

Part Number	Dimensions (mm)							Std Pack Qty
	D	d ₂	d ₁	h ₁	d ₄	d ₃	h ₂	
12462	15.1	12.7	9.5	3.2	14.3	11.9	35.5	4000
51409	19.1	12.7	9.7	0.8	15.1	12.2	26.8	4000

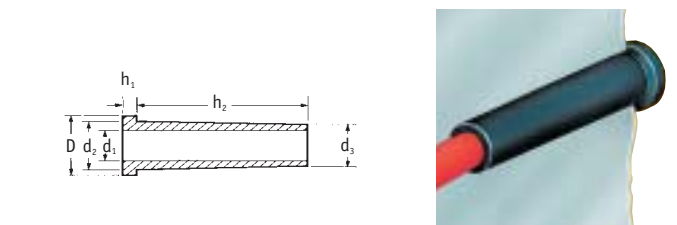

SR 1707

Universal Bushes

Black Nylon

- Effortless snap-fit into panels
- Protect against rough hole edges
- Ideal for wire, cable and irregular-shaped items

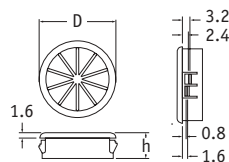

Part Number	Panel Dimensions (mm)		Part Dimensions (mm)			Std Pack Qty
	Mounting Hole Dia	Max Panel Thickness	Max I.D.	D	h	
110534	15.9	3.2	11.1	18.2	10.3	1000
110535	19.0	3.2	12.7	21.8	9.9	1000
110536	20.6	3.2	12.7	22.6	9.9	1000
110537	22.2	3.2	14.2	23.8	11.5	1000
110538	25.4	3.2	19.0	26.9	11.5	1000
110539	27.8	3.2	20.6	29.3	11.5	1000

Multi-Cable Grommet

- Suits cables 8 to 17mm in diameter
- Fits 20mm hole
- Graduated sleeve can be cut to requirements

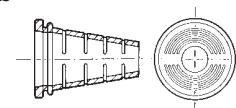

Part Number	Dimensions (mm)			Std Pack Qty
	Hole Size	Panel Thickness	Cable Range	
12312	20.0	1.6	8.0-17.0	1000



Snap-Fit Bushes, Vent and Blanking Plugs

SR 1706

Snap-Fit Bushes

Black Nylon –
(Heat Stabilised to UL94 V2)

- Effortless snap-fit into panels
- Easy installation, no tools required
- Protect against rough panel hole edges

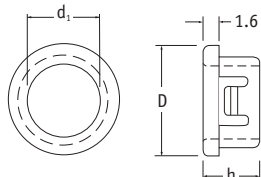

Part Number	Panel Dimensions (mm)		Part Dimensions (mm)			Std Pack Qty
	Mounting Hole Dia	Max Panel Thickness	d ₁	D	h	
110492	6.6	1.6	3.2	8.0	8.0	1000
110493	8.0	1.6	4.8	9.5	8.0	1000
110494	9.5	3.2	4.8	11.9	10.3	1000
110495	9.5	3.2	6.4	11.9	10.3	1000
110496	11.0	3.2	6.4	13.5	10.3	1000
110497	11.0	3.2	8.0	13.5	10.3	1000
110498	11.0	3.2	6.2	13.5	10.3	1000
110499	12.7	3.2	6.4	14.7	10.3	1000
110500	12.7	3.2	8.0	14.7	10.3	1000
110501	12.7	3.2	9.5	14.7	10.3	1000
110502	14.3	3.2	8.0	16.7	10.3	1000
110503	14.3	3.2	9.5	16.7	10.3	1000
110504	14.3	3.2	11.0	16.7	10.3	1000
110505	15.9	3.2	6.4	18.2	10.3	1000
110506	15.9	3.2	11.0	18.2	10.3	1000
110507	15.9	3.2	12.7	18.2	10.3	1000
110508	17.5	3.2	12.7	19.8	10.3	1000
110509	17.5	3.2	14.3	19.8	10.3	1000
110510	19.0	3.2	9.5	21.4	10.3	1000
110511	19.0	3.2	12.7	21.4	10.3	1000
110512	19.0	3.2	14.3	21.4	10.3	1000
110513	19.0	3.2	16.0	21.4	10.3	1000
110514	20.6	3.2	14.3	22.6	10.3	1000
110515	20.6	3.2	16.0	22.6	10.3	1000
110516	22.2	3.2	9.5	24.2	11.5	1000
110517	22.2	3.2	11.0	24.2	11.5	1000
110518	22.2	3.2	12.7	24.2	11.5	1000
110519	22.2	3.2	14.3	24.2	11.5	1000
110520	22.2	3.2	16.0	24.2	11.5	1000
110521	22.2	3.2	17.5	24.2	11.5	1000
110522	25.4	3.2	19.0	28.6	11.5	1000
110523	27.8	3.2	20.5	30.9	11.5	1000
110524	27.8	3.2	22.0	30.9	11.5	1000
110525	27.8	3.2	24.0	30.9	11.5	1000
110526	30.2	3.2	24.0	33.3	11.5	1000
110527	32.0	3.2	24.0	34.5	11.5	1000
110528	34.9	3.2	25.4	37.3	11.5	1000
110529	38.0	3.2	27.0	40.9	11.5	1000
110530	38.0	3.2	28.5	40.9	11.5	1000
110531	38.0	3.2	33.3	40.9	11.5	1000
110532	45.0	3.2	35.0	47.6	11.5	1000
110533	51.0	3.2	41.0	54.0	11.5	1000

SR 1086

Domed Blanking Plugs

Black or White Nylon –
(Heat Stabilised to UL94 V2)

- Snap into panel thicknesses of 1.6 to 3.2mm
- Ideal for closing panel cavities from 4.8 to 51mm in diameter

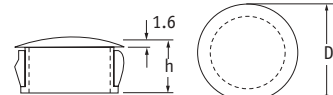

Part Number	Panel Dimensions (mm)		Part Dimensions (mm)		Std Pack Qty	
	Black	White	Mounting Hole Dia	Max Panel Thickness		
460006	462727	4.8	1.6	6.4	5.9	1000
460007	462728	6.4	1.6	8.0	8.0	1000
460008	462729	8.0	1.6	9.5	8.0	1000
460009	462730	9.5	3.2	12.0	10.0	1000
460010	462731	11.0	3.2	13.5	10.3	1000
460011	462732	12.7	3.2	14.6	10.3	1000
460012	461285	14.3	3.2	16.7	10.3	1000
460013	462733	15.9	3.2	18.2	10.3	1000
460014	462734	17.5	3.2	20.0	10.3	1000
460015	462735	19.0	3.2	23.2	10.3	1000
460016	462736	20.6	3.2	22.6	10.3	1000
460017	462737	22.2	3.2	25.8	11.5	1000
460018	462738	25.4	3.2	30.5	11.5	1000
460019	462739	27.8	3.2	31.0	11.5	1000
460020	462740	30.0	3.2	33.3	11.5	1000
460021	462741	32.0	3.2	34.9	11.5	1000
460022	462742	35.0	3.2	38.0	11.5	1000
460023	462743	38.0	3.2	42.7	11.5	1000
460024	462744	45.0	3.2	48.4	11.5	500
460025	462745	51.0	3.2	55.0	11.5	500

SR 1708

Vent Plugs

Black Nylon

- Provide ventilation access for cooling fans, moving parts and heat-emitting components

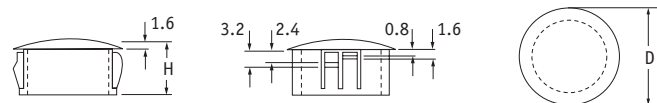
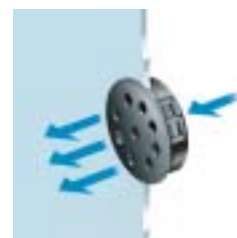

Part Number	Panel Dimensions (mm)		Part Dimensions (mm)		Std Pack Qty
	Mounting Hole Dia	Max Panel Thickness	D	H	
110490	22.2	3.2	25.8	11.5	1000
110491	25.4	3.2	30.5	11.5	1000

Please request a free sample to evaluate the suitability of a product for your application.



Grommet Strips and Blanking Plugs

SR 1760 Snap-Fit Blanking Plugs

Natural Low-Density Polyethylene

- Ideal for metal panels up to 2.5mm thick
- Snap neatly into position

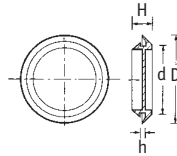

Part Number	Dimensions (mm)				Std Pack Qty
	D	d	h	H	
10923	20.0	9.5	3.0	8.5	5000
12540	24.0	12.5	3.0	9.8	5000
12975	27.0	14.0	3.0	10.0	5000
12541	27.5	16.0	3.0	9.8	5000
12542	30.5	19.0	3.0	9.8	5000
12543	31.5	20.0	3.0	9.8	5000
12544	33.5	22.0	3.0	9.8	5000
12545	36.5	25.0	3.0	9.8	3000
12546	39.5	28.0	3.0	9.8	2500
12976	41.0	31.5	3.0	9.2	2000
12547	49.5	38.0	3.0	9.8	1500
12631	59.0	47.5	3.0	9.8	1500
12548	61.5	50.0	3.0	9.8	1000
12632	62.5	51.0	3.0	9.5	1000

SR 1750/1751 Blanking Plugs

SR 1750 Black PVC

SR 1751 Black Thermoplastic Rubber

- Ideal for metal panels
- Acid-resistant
- Withstand temperatures between -40°C and +135°C

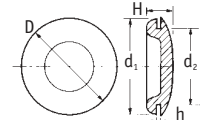

Part Number	SR 1750 PVC	SR 1751 TPR	Dimensions (mm)				Std Pack Qty	
			D	d ₁	d ₂	h		H
10860	15150		9.3	9.3	4.7	1.6	4.6	10000
10825	15151		9.5	9.5	6.4	1.6	5.0	10000
10832	-		14.5	10.6	8.0	0.8	4.0	10000
10233	-		14.5	10.6	8.0	1.6	4.5	10000
10488	-		15.0	12.4	9.0	1.6	6.6	10000
10912	15155		17.7	12.8	11.2	1.6	6.2	10000
10768	-		17.0	15.5	11.5	1.6	7.0	10000
15511	-		17.5	15.9	11.9	1.2	7.1	10000
50680	-		19.0	13.1	12.0	0.8	6.5	10000
10502	15157		18.7	15.5	12.7	1.6	5.6	10000
11321	15158		20.0	18.4	14.9	1.3	7.0	10000
10213	15159		22.0	19.0	15.5	1.6	7.5	10000
40043*	-		19.0	19.0	15.9	1.6	7.1	10000
12914	-		20.0	18.5	16.3	1.3	7.0	10000
10678	15160		25.0	21.5	19.0	1.6	6.5	5000
10499	15161		25.0	21.5	20.0	1.6	6.5	3000
11152	15162		28.5	26.6	22.0	2.4	8.2	3000
10902	-		28.5	27.0	22.5	1.6	7.5	3000
11027	15164		30.0	27.5	24.5	2.4	8.7	4000
10705	15166		32.0	28.3	25.4	1.6	9.0	3000
11148	15165		32.0	28.3	25.4	2.4	9.0	3000
11323	-		38.5	28.5	25.0	0.8	4.6	3000
11281	15170		38.2	35.4	32.0	3.1	9.0	2000
11239	-		38.2	31.5	31.5	0.8	7.0	2000
11059	15168		38.2	35.4	31.5	1.6	7.5	2000
10877	15171		43.7	43.0	38.2	1.6	8.2	1500
10320	15172		57.5	52.6	51.5	1.6	12.4	1000

* Solid style, no recess on blind side.

SR 1765 Body Plugs

Black Thermoplastic Rubber

- Quick to fit
- Each size covers a range of panel thicknesses
- Withstand temperatures between -40°C and +135°C

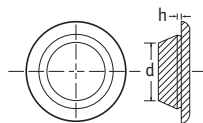

Part Number	Dimensions (mm)		Std Pack Qty
	d	h	
16230	10.0	0.8-2.0	5000
16231	12.0	0.8-2.0	5000
16232	14.0	0.8-2.0	5000
16233	16.0	0.8-2.0	5000
16234	18.0	0.8-2.0	2500
16235	20.0	0.8-2.0	2500
16236	22.0	0.8-2.0	2500
16237	25.0	0.8-2.0	3000
16238	30.0	0.8-2.0	2000
10517	45.0	0.8-2.0	1000

SR 1712 Grommet Strips

Natural Polythene

- Protect against damage from sharp panel edges
- Ideal for tight radii in panel cut-outs and holes

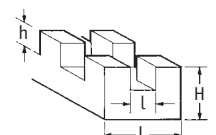
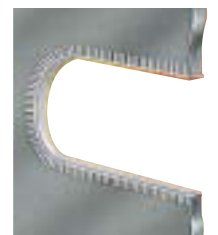

Part Number	Dimensions (mm)				Std Pack Qty (metres)
	L	l	H	h	
49087	2.2	0.9	2.4	1.8	25
49088	3.8	1.4	4.0	2.5	25
49089	4.5	2.3	4.0	2.5	25
49090	5.6	3.3	4.0	2.5	25
49091	8.3	5.0	5.8	4.0	25
49092	9.8	6.6	6.1	4.3	25

Other sizes available; please contact our sales office for more details.

For guidance, please refer to our Materials Properties Chart on page 184.



Grommets, Strain Relief Bushes and Cable Wrap

SR 1703 Grommets (IP67)

Grey EPDM

- Provide dust and watertight seal
- Suitable for external applications
- Conform to IP67 standard
- Act as a blanking plug until cable is installed
- Withstand vibration
- Quick and easy to install:
 1. Press into hole
 2. Puncture diaphragm by inserting wire
 3. Gently pull cable back to secure

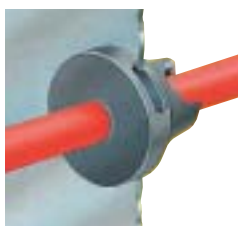

Part Number	Panel Hole (mm)	Panel Thickness (mm)	Cable Size (mm)	Std Pack Qty
199017*	12.5	0.5-2	3-5	1000
39897	16.0	1-4	5-7	1000
34715	19.0	1-4	7-10	1000
34716	23.0	1-4	10-14	1000
43021	29.0	1-4	14-20	1000

* Black thermoplastic rubber and style variation.

SR 1709 Stepped Grommets

Black PVC

- Stepped sleeve can be cut to requirements
- Suit a range of cable diameters
- Protect cables passing through panels
- Act as blanking plug until cut

new

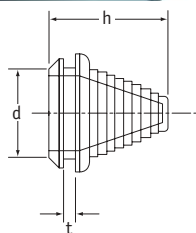

Part Number	Dimensions (mm)			Cable Range	Std Pack Qty
	d	t	h		
462039	12.7	3	32.5	5-9	1000
462040	21.0	3	27.5	5-17	1000
462041	26.0	3	29.5	10-22	1000

Please request a free sample to evaluate the suitability of a product for your application.

SR 1711 Strain Relief Bushes

Black Nylon 6.6

- Eliminate cable strain and wear
- Withstand temperatures up to +140°C
- Crimped onto cable and inserted into hole using tool part number 34811
- For round or elongated holes

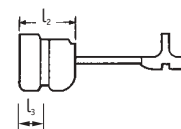
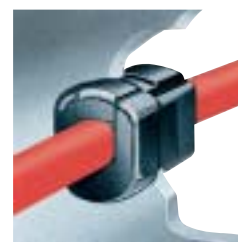

Installation tool

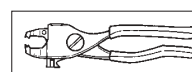

Part Number
34811

Hole shapes

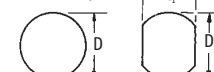

Part Number	Fits Cable		Hole Size (mm)		Max Panel Thickness (mm)	Dim (mm)			Std Pack Qty
	Shape	Size (mm)	D	l ₁		l ₂	l ₃		
34830	Flat	3.8 x 7.1	12.7	11.8	2.5	12.7	4.3	500	
		4.1 x 7.6	13.1	11.8	2.5	12.7	4.3	500	
460992	Flat	3.0 x 7.6	12.7	11.8	1.6	10.3	-	1000	
460993	Flat	3.0 x 7.6	12.7	11.8	2.5	10.3	-	1000	
460994	Flat	3.8 x 10.1	12.7	11.7	2.4	12.6	-	1000	
460995	Round	6.4	12.7	11.4	1.6	11.1	-	1000	
460996	Round	6.4	12.7	11.4	2.5	11.1	-	1000	
460997*	Round	6.4-6.7	12.7	11.4	2.5	17.5	-	1000	
34831	Round	6.4-6.7	12.7	11.8	2.5	10.9	4.2	500	
		6.8-7.4	13.1	11.8	2.5	10.9	4.2	1000	
34832	Round	7.6-8.3	16.7	14.5	3.2	17.3	7.0	500	
		8.4-9.0	17.5	14.5	3.2	17.3	7.0	1000	
460998	Round	7.2	15.9	14.0	1.6	14.7	-	500	
460999	Round	7.6	12.7	11.8	2.3	11.1	-	1000	
461000	Round	8.3-9.1	15.9	14.0	3.2	14.7	-	500	
461001	Round	8.3-10.9	15.9	14.0	3.2	16.9	-	500	
461002	Round	8.3-9.1	22.2	19.6	3.2	19.1	-	250	
461003	Round	9.0	15.9	14.0	1.6	14.7	-	1000	
34811	Installation tool								1

* 90° angled bush.

SR 1723 Rapid Cable Wrap

Black Polypropylene

- Crush resistant
- Tough durable protection for cable looms
- Protects against damage and wear without restricting flexibility
- Easy to install with special tool (please specify tool when ordering)
- Also available in nylon



Part Number	Cable Wrap	Installation Tool	Dimensions (mm)		Std Pack Qty (metres)
			Internal Diameter	Maximum Bundle Dia	
43459	43460		8.0	10.0	100
43461	43462		15.0	16.0	50
43463	43464		20.0	23.0	30
43465	43466		25.0	25.0	20



SR 1714 Cable Glands Polyamide 6

- Reduce potential cable damage
- Seal a wide range of cable diameters
- Choice of black, grey or light grey
- Incorporate neoprene seal and locknut
- Operating range -30°C to +80°C

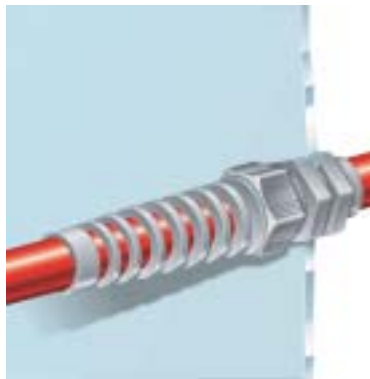

SR 1704 Cable Glands Polyamide 6

- Protection rating IP68
- Easy to assemble
- Reduce potential cable damage
- Seal a wide range of cable diameters
- Choice of black or grey
- Incorporate neoprene seal and locknut
- Operating range -30°C to +80°C

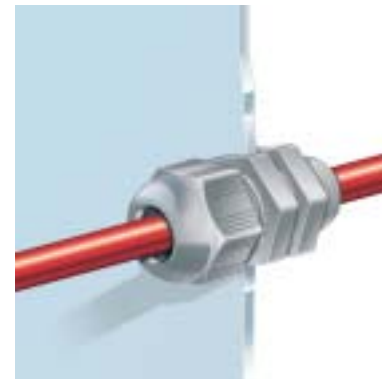

Part Number	Colour	Mounting Thread Size (mm)	Mounting Thread Length (mm)	Cable Diameter (mm)	Std Pack Qty
460477	Grey	12.0	8.0	3.0-6.5	50
460478	Grey	16.0	10.0	5.0-10.0	25
460479	Grey	20.0	10.0	6.0-12.0	25
460480	Grey	20.0	10.0	10.0-14.0	25
460481	Grey	25.0	10.0	13.0-18.0	10
460482	Black	12.0	8.0	3.0-6.5	50
460483	Black	16.0	10.0	5.0-10.0	25
460484	Black	20.0	10.0	6.0-12.0	25
460485	Black	20.0	10.0	10.0-14.0	25
460486	Black	25.0	10.0	13.0-18.0	10
460472	Light Grey	12.0	8.0	3.0-6.5	50
460473	Light Grey	16.0	10.0	5.0-10.0	25
460474	Light Grey	20.0	10.0	6.0-12.0	25
460475	Light Grey	20.0	10.0	10.0-14.0	50
460476	Light Grey	25.0	10.0	13.0-18.0	10

Grey (RAL 7001), Black (RAL 9005), Light Grey (RAL 7035).



PG Thread Range

Part Number		Mounting Hole (mm)	Mounting Thread Size (mm)	Cable Range (mm)	Std Pack Qty	
Black	Grey					
462600	462646	PG-7	11.9	8.0	3.5-6.0	50
462601	462647	PG-9	15.5	8.1	4.0-8.0	50
462602	462648	PG-9	14.3	14.67	4.0-8.0	50
462603	462649	PG-11	17.9	7.33	5.0-10.0	50
462604	462650	PG-11	18.2	14.85	5.0-10.0	50
462605	462651	PG-13.5	19.9	8.9	6.0-12.0	50
462606	462652	PG-16	21.6	9.9	10.0-14.0	50
462607	462653	PG-21	27.7	9.7	13.0-18.0	50
462608	462654	PG-29	36.5	11.4	18.0-25.0	25
462609	462655	PG-36	46.0	13.3	22.0-32.0	10
462610	462656	PG-42	53.4	14.6	30.0-38.0	10
462611	462657	PG-48	58.2	14.1	34.0-44.0	10



Metric Thread Range

Part Number		Mounting Hole (mm)	Mounting Thread Size (mm)	Cable Range	Std Pack Qty
Black	Grey				
462612	462658	12.0	8.0	3.0-6.5	50
462613	462659	16.0	9.8	5.0-8.0	50
462614	462660	20.0	8.2	6.0-12.0	50
462615	462661	25.0	10.0	13.0-18.0	50
462616	462662	32.0	14.7	18.0-25.0	25
462617	462663	40.0	13.9	22.0-32.0	10
462618	462664	50.0	14.5	30.0-38.0	10
462619	462665	63.0	14.0	34.0-44.0	10

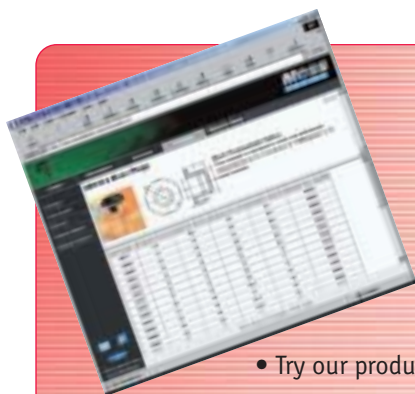

Use the Web...

- Try our product selector
- Request literature, product samples and quotations
- View our complete product range
- Search for specific products by part number or keyword
- Find product information, latest products and news
- Place your order direct

www.mossplastics.com



Cable Ties

SR 1785 Standard Cable Ties Nylon 66

- Tough and flexible
- Lock to prevent accidental removal
- Flammability rating: UL94 V2
- Comply with military specifications MS-3367 and MIL-S-23190E
- All sizes available from stock

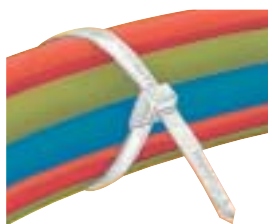

SR 1785 Heavy-Duty Cable Ties

Natural Nylon 66

Benefits as standard version plus:

- Higher tensile strength for more demanding applications



Part Number		Max Cable Bundle Dia (mm)	Dimensions (mm)		Tensile LBS/kg	Std Pack Qty
Natural	Black		Length	Width		
460237	461883	63.0	230.0	12.7	250/114	100
460238	461884	80.0	280.0	12.7	250/114	100
460239	461885	110.0	380.0	12.7	250/114	100
460240	461886	140.0	480.0	12.7	250/114	100
460241	461887	166.0	550.0	12.7	250/114	100
460242	461888	175.0	580.0	12.7	250/114	100
460243	461889	225.0	730.0	12.7	250/114	100
460244	461890	267.0	880.0	12.7	250/114	100
460245	461891	317.0	1030.0	12.7	250/114	100



Part Number		Max Cable Bundle Dia (mm)	Dimensions (mm)		Tensile LBS/kg	Std Pack Qty
Natural	Black		Length	Width		
460175	460206	15.0	75.0	2.4	18/8	100
460176	460207	21.0	96.0	2.5	18/8	100
460177	460208	25.0	100.0	2.5	18/8	100
460178	460209	30.0	120.0	2.5	18/8	100
460179	460210	35.0	142.0	2.5	18/8	100
460180	460211	44.0	165.0	2.5	18/8	100
460181	460212	55.0	203.0	2.5	18/8	100
460182	460213	30.0	120.0	3.2	40/18	100
460183	460214	35.0	142.0	3.2	40/18	100
460185	460216	55.0	203.0	3.2	40/18	100
460184	460215	39.0	150.0	3.6	40/18	100
460194	460225	49.0	180.0	3.6	50/22	100
460186	460217	55.0	203.0	3.6	40/18	100
460187	460218	74.0	250.0	3.6	40/18	100
460188	460219	78.0	265.0	3.6	40/18	100
460189	460220	85.0	292.0	3.6	40/18	100
460190	460221	96.0	331.0	3.6	40/18	100
460191	460222	102.0	368.0	3.6	40/18	100
460192	460223	30.0	120.0	4.8	50/22	100
460193	460224	42.0	160.0	4.8	50/22	100
460195	460226	52.0	190.0	4.8	50/22	100
460196	460227	55.0	203.0	4.6	50/22	100
460197	460228	74.0	250.0	4.8	50/22	100
460198	460229	81.0	280.0	4.8	50/22	100
460199	460230	85.0	295.0	4.8	50/22	100
460200	460231	89.0	310.0	4.8	50/22	100
460201	460232	102.0	368.0	4.8	50/22	100
460202	460233	116.0	385.0	4.8	50/22	100
460203	460234	125.0	432.0	4.8	50/22	100
460204	460235	130.0	450.0	4.8	50/22	100
460205	460236	150.0	500.0	4.8	50/22	100
461165	461182	39.0	150.0	7.6	120/55	100
461166	461183	55.0	203.0	7.6	120/55	100
461167	461184	66.0	240.0	7.6	120/55	100
461168	461185	78.0	280.0	7.6	120/55	100
461169	461186	88.0	300.0	7.6	120/55	100
461170	461187	99.0	340.0	7.6	120/55	100
461171	461188	110.0	380.0	7.6	120/55	100
461172	461189	133.0	450.0	8.0	175/80	100
461173	461190	166.0	550.0	8.0	175/80	100
461174	461191	185.0	610.0	9.0	175/80	100
461175	461192	210.0	685.0	9.0	175/80	100
461176	461193	220.0	710.0	9.0	175/80	100
461177	461194	236.0	762.0	9.0	175/80	100
461178	461195	246.0	812.0	9.0	175/80	100
461179	461196	270.0	914.0	9.0	175/80	100
461180	461197	360.0	1168.0	9.0	175/80	100
461181	461198	380.0	1219.0	9.0	175/80	100

SR 1785 UV-Resistant Cable Ties

Black Nylon 66

Benefits as standard version plus:

- UV-resistant for outdoor use



Part Number	Max Cable Bundle Dia (mm)	Dimensions (mm)		Tensile LBS/kg	Std Pack Qty
		Length	Width		
460246	18.0	75.0	2.4	18/8	100
460247	23.0	96.0	2.5	18/8	100
460248	25.0	100.0	2.5	18/8	100
460249	30.0	120.0	2.5	18/8	100
460250	35.0	142.0	2.5	18/8	100
460251	44.0	165.0	2.5	18/8	100
460252	55.0	203.0	2.5	18/8	100
460253	30.0	120.0	3.2	40/18	100
460254	35.0	142.0	3.2	40/18	100
460256	55.0	203.0	3.2	40/18	100
460255	39.0	150.0	3.6	40/18	100
460257	55.0	203.0	3.6	40/18	100
460258	74.0	250.0	3.6	40/18	100
460259	78.0	265.0	3.6	40/18	100
460260	85.0	292.0	3.6	40/18	100
460261	96.0	331.0	3.6	40/18	100
460262	102.0	368.0	3.6	40/18	100
460265	49.0	180.0	4.0	50/22	100
460263	30.0	120.0	4.8	50/22	100
460264	42.0	160.0	4.8	50/22	100
460266	52.0	190.0	4.8	50/22	100
460267	55.0	203.0	4.6	50/22	100
460268	74.0	250.0	4.8	50/22	100
460269	81.0	280.0	4.8	50/22	100
460270	85.0	295.0	4.8	50/22	100
460271	89.0	310.0	4.8	50/22	100
460272	102.0	368.0	4.8	50/22	100
460273	116.0	385.0	4.8	50/22	100
460274	125.0	432.0	4.8	50/22	100



SR 1785 Mounting Ties

Natural and Black Nylon 66

Benefits as standard version plus:

- Moulded fixing head
- Ideal for fixing to either metal or wooden panels
- Tie can be screwed or bolted down
- Versatile and easy to use
- Can be fitted to existing installations before final assembly



Part Number		Max Cable Bundle Dia (mm)	Dimensions (mm)		Tensile LBS/kg	Std Pack Qty
Natural	Black		Length	Width		
461242	461261	25.0	100.0	2.5	18/8	100
461243	461262	40.0	155.0	3.7	40/18	100
461244	461263	60.0	205.0	4.2	50/22	100
461245	461264	85.0	300.0	4.8	50/22	100
461246	461265	102.0	370.0	4.8	50/22	100
461247	461266	122.0	398.0	7.9	120/55	100

SR 1785 Releasable Ties

Natural and Black Nylon 66

Benefits as standard version plus:

- Ties remain locked until intentionally released
- Ideal in a variety of applications where temporary fastening or servicing is required
- Type 2 features a push button for easy release



Part Number		Max Cable Bundle Dia (mm)	Dimensions (mm)		Tensile LBS/kg	Std Pack Qty
Natural	Black		Length	Width		
Type 1						
461253	461272	25.0	100.0	3.6	40/18	100
461254	461273	39.0	150.0	4.7	50/22	100
461255	461274	55.0	200.0	4.7	50/22	100
461256	461275	74.0	250.0	4.8	50/22	100
461257	461276	88.0	300.0	4.8	50/22	100
461258	461277	102.0	370.0	4.8	50/22	100
Type 2						
461267	461248	30.0	125.0	7.6	50/22	100
461268	461249	35.0	150.0	7.6	50/22	100
461269	461250	50.0	200.0	8.0	50/22	100
461270	461251	65.0	250.0	7.6	50/22	100
461271	461252	80.0	300.0	8.0	50/22	100

SR 1785 Push Mount Ties

Natural and Black Nylon 66

Benefits as standard version plus:

- Simple and easy to use
- Snap into holes and are then securely fixed to the panel
- Ties can be mounted to existing installations before final assembly
- Type 2 is releasable – ideal for use when maintenance repair work will be required
- Type 3 head profile holds tie securely in panel
- Type 4 includes a release mechanism to remove the tie from the panel after use

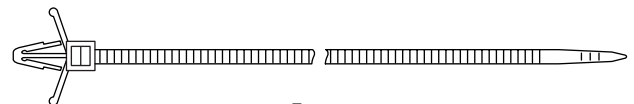

Type 1

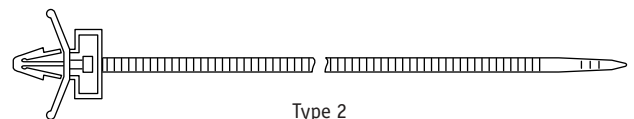

Type 2

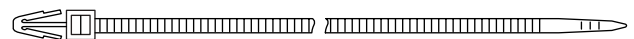

Type 3



Type 4

Part Number		Type	Max Cable Bundle Dia (mm)	Dimensions (mm)		Tensile LBS/kg	Mounting Hole (mm)	Std Pack Qty
Natural	Black			Length	Width			
461260	461279	1	40.0	155.0	3.5	40/18	4.8	100
462761	462700	1	50.0	203.0	4.8	50/22	4.8	100
462762	462701	1	50.0	203.0	4.8	50/22	6.0	100
462763	462702	1	30.0	132.5	4.8	50/22	6.4	100
462764	462703	1	50.0	200.0	4.8	50/22	6.4	100
461259	461278	2	37.0	150.0	8.0	90/40	5.4	100
462765	462704	3	25.0	112.0	2.5	18/8	4.0	100
462766	462705	3	30.0	130.0	4.8	50/22	6.0	100
462695	462706	3	36.0	155.0	3.5	40/18	4.0	100
462696	462707	3	50.0	200.0	4.8	50/22	6.0	100
462697	462708	4	30.0	132.5	3.5	40/18	4.8	100
462698	462709	4	36.0	155.0	3.5	40/18	4.8	100
462699	462710	4	50.0	200.0	3.5	40/18	4.8	100



Cable Ties

SR 1785 Belt Ties

PE

- For simple bundling of electrical wires
- Flexible design
- Quick release

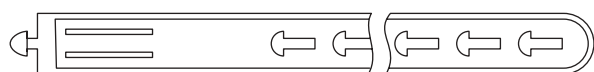

Type 1



Type 2

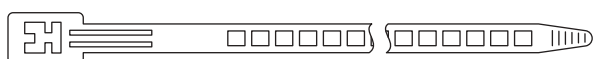

Type 3

Part Number		Type	Max Cable Bundle Dia (mm)	Dimensions (mm)		Tensile LBS/kg	Std Pack Qty
Natural	Black			Length	Width		
462689	462692	1	35.0	130.0	15.0	30/14	100
462690	462693	2	45.0	160.0	9.0	18/8	100
462691	462694	3	38.0	140.0	9.0	18/8	100

SR 1785 Hook and Loop Ties

Black

- Easy to use
- Simple application, adjustment and re-use
- Do not crush the cables being tied
- Ideal for fragile cables



Part Number	Max Cable Bundle Dia (mm)	Dimensions (mm)		Std Pack Qty
		Length	Width	
462711	30.0	125.0	12.0	20
462712	33.0	135.0	12.0	20
462713	40.0	180.0	12.0	20
462714	50.0	210.0	16.0	20
462715	85.0	310.0	16.0	20

SR 1785 Marker Ties

Natural Nylon 66

Benefits as standard version plus:

- Identification tag can be written on
- Different tag sizes to suit application
- Printing available on request (minimum order quantities apply)



Type 1



Type 2

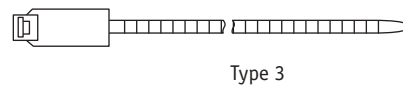

Type 3

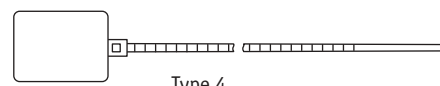

Type 4

Part Number	Type	Max Cable Bundle Dia (mm)	Dimensions (mm)		Tag Size (mm)	Tensile LBS/kg	Std Pack Qty
			Length	Width			
462671	1	25.0	100.0	2.5	25 x 8	18/8	100
462672	1	50.0	200.0	2.5	30 x 15	18/8	100
462673	2	25.0	110.0	2.5	25 x 8	18/8	100
462674	3	50.0	200.0	4.6	28 x 13	50/22	100
462675	3	75.0	270.0	4.6	28 x 13	50/22	100
462676	4	25.0	130.0	2.5	28 x 20	18/8	100

SR 1785 Metal Ties

Steel

- Self locking, easily installed by hand
- Resistant to extreme temperatures
- Offer great strength and durability

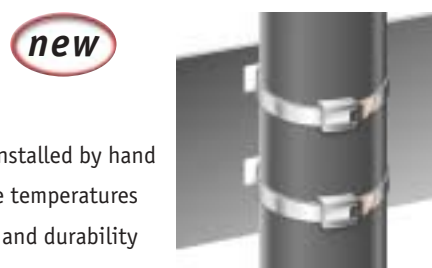

Part Number	Max Cable Bundle Dia (mm)	Dimensions (mm)		Tensile LBS/kg	Std Pack Qty
		Length	Width		
462717	25.0	152.0	4.6	96/44	200
462718	50.0	201.0	4.6	96/44	200
462719	102.0	360.0	4.6	96/44	200
462720	152.0	520.0	4.6	96/44	200
462721	203.0	679.0	4.6	96/44	200
462722	50.0	201.0	7.9	242/110	200
462723	102.0	362.0	7.9	242/110	200
462724	152.0	521.0	7.9	242/110	200
462725	203.0	679.0	7.9	242/110	200
462726	253.0	838.0	7.9	242/110	200



SR 1785 *new* Ball Cable Ties

Nylon 66

- Design allows ties to be easily applied and released
- Tie design prevents slipping

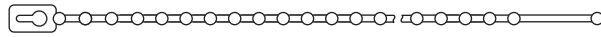

Type 1

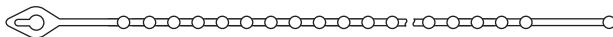

Type 2

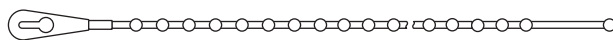

Type 3

Part Number		Type	Max Cable Bundle Dia (mm)	Dimensions (mm) Length	Tensile LBS/kg	Std Pack Qty
Natural	Black					
462677	462683	1	25.0	100.0	18/8	100
462678	462684	1	30.0	120.0	18/8	100
462679	462685	2	39.0	150.0	30/14	100
462680	462686	2	49.0	180.0	40/18	100
462681	462687	2	75.0	280.0	75/50	100
462682	462688	3	63.0	226.0	40/18	100

SR 1726 Twist Ties

Natural Nylon 66

- Reusable and releasable for easy wire bundling
- Easy open-and-twist fit to cables
- Flammability rating UL94 V2

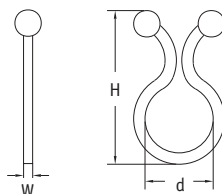

Part Number	Cable Bundle Dia (mm)	Dimensions (mm)			Std Pack Qty
		d	H	W	
460341	4-7	5.1	20.6	1.8	100
460342	7-10	8.0	25.4	1.8	100
460343	10-13	11.3	29.3	1.8	100
460344	13-16.5	15.0	34.0	2.0	100
460345	16.5-20	18.6	40.0	2.0	100
460346	20-26	24.0	45.5	2.0	100

Other colours are available; please contact our sales office for more details.

SR 1727 Adhesive Twist Ties

Natural Nylon 66

- Strong adhesion for quick and easy installation
- Reusable and releasable for easy wire bundling
- Easy open-and-twist fit to cables
- Flammability rating UL94 V2

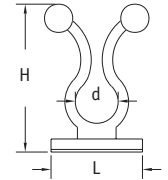

Part Number	Cable Bundle Dia (mm)	Dimensions (mm)			Std Pack Qty
		d	H	L	
460347	7-10	7.9	27.5	17.4	100
460348	10-15	14.8	35.2	22.0	100
460349	15-20	20.6	40.0	25.5	100

SR 1728 Push-In Twist Ties

Natural Nylon 66

- Reusable and releasable for easy wire bundling
- Easy open-and-twist fit to cables
- Simple one-push fit
- Flammability rating UL94 V2
- Lock into 4.8mm hole

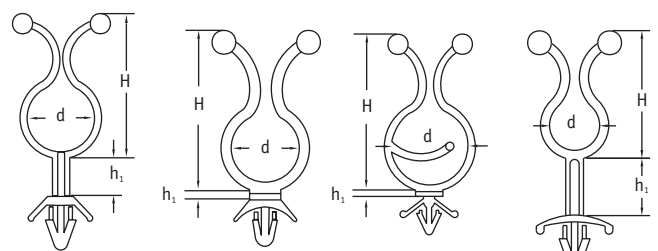

Type 1

Type 2

Type 3

Type 4

Part Number	Type	Dimensions (mm)			Std Pack Qty
		H	h ₁	d	
460350	1	21.0	31.0	6.0	100
460351	1	30.0	18.0	11.0	100
460352	1	30.0	4.0	11.0	100
460353	1	30.8	3.0	11.0	100
460356	1	30.0	12.7	11.0	100
460357	1	33.7	8.7	15.2	100
460358	1	21.6	58.3	5.0	100
460361	1	32.0	2.5	16.0	100
460362	1	43.2	3.1	24.0	100
460354	2	30.7	2.3	14.8	100
460355	3	34.9	2.0	18.2	100
460359	4	25.3	12.2	11.0	100
460360	4	26.3	46.6	12.0	100



Tie Mounts

SR 1718 Adhesive Tie Mounts

Natural Nylon 66

- Strong adhesion for quick and easy installation
- Ideal for lightweight wire bundles
- Flammability rating UL94 V2
- Panel hole for optional screw fixing

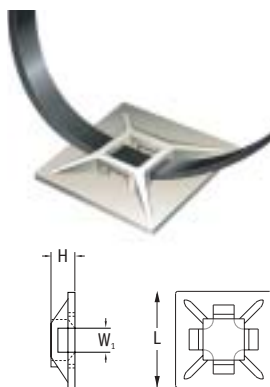

Part Number	Tie Width (mm)	Dimensions (mm)			Panel Hole Dia (mm)	Std Pack Qty
		W ₁	L	H		
460329	2.4-3.2	3.2	12.5 x 12.5	3.2	—	100
460330	2.4-3.6	4.5	19 x 19	3.9	3.2	100
460331	2.4-3.6	4.7	21 x 21	3.5	—	100
460332	2.4-4.8	5.0	28 x 28	4.0	5.0	100
460333	2.4-4.8	5.0	28 x 28	4.0	5.0	100
460334	2.4-4.5	4.5	18 x 18	4.5	5.0	100

Exact style may alter by size; please ask for samples if in doubt.

SR 1719 Screw-In Tie Mounts

Natural Nylon 66

- Easy screw fixing
- Give maximum stability to wire bundle
- Flammability rating UL94 V2

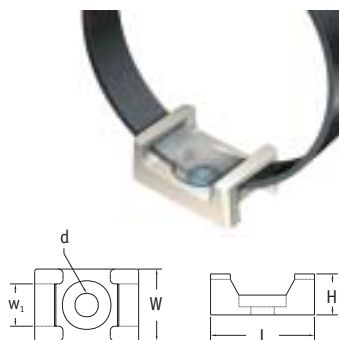

Part Number	Tie Size (mm)	Dimensions (mm)				Panel Hole d (mm)	Std Pack Qty
		W ₁	L	H	W		
460335	2.4-4.8	5.0	19.0	5.0	9.5	3.4	100
460336	2.4-4.8	5.0	15.0	7.0	10.0	3.0	100
460337	2.4-9	9.0	23.0	9.0	16.0	6.0	100
460338	2.4-9	9.5	23.0	17.5	13.8	5.3	100
460339	2.4-9	9.3	30.0	11.6	14.7	5.2	100

Exact style may alter by size; please ask for samples if in doubt.

SR 1717 Push-In Tie Mounts

- Easy one-push fit
- One standard panel hole diameter of 6.2mm
- Flammability rating UL94 V2

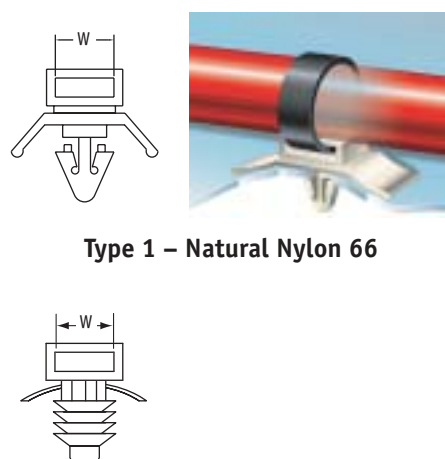

Type 1 – Natural Nylon 66

Type 2 – Black Nylon 66



Part Number	Type	Dimensions (mm)		Std Pack Qty
		W	H	
460327	1	4.0	—	100
460328	1	8.1	—	100
462716	2	5.0	—	100

Urgent Deliveries

We can arrange special deliveries to suit your very urgent needs – just call us.



Over 400 million parts in stock for a rapid response to your order



SR 1780 Standard Cleats Black LDPE

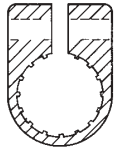

Part Number	Size Number	Cable Size (mm)	Fixing (mm)	Std Pack Qty	Carton Qty
12875	3	7.6	6.0 (1/4")	100	3000
12876	4	10.1	6.0 (1/4")	100	2500
12877	5	12.7	6.0 (1/4")	100	2500
12848	6	15.2	6.0 (1/4")	100	2000
12878	7	17.8	6.0 (1/4")	100	2000
12879	8	20.3	6.0 (1/4")	100	1000
12880	9	22.8	6.0 (1/4")	100	1000
12881	10	25.4	6.0 (1/4")	100	800
12092	11	27.9	9.6 (3/8")	100	800
12882	12	30.0	10.0 (3/8")	50	600
12883	14	35.6	10.0 (3/8")	50	500
12884	16	40.6	10.0 (3/8")	50	500
12885	18	45.7	10.0 (3/8")	50	400
12886	20	50.4	10.0 (3/8")	50	300

SR 1793 Cable Clips Natural Nylon

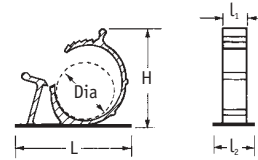

Part Number	Dia Range (mm)	Dimensions (mm)				Std Pack Qty
		L	l ₂	H	l ₁	
32543	11.9-14.3	37.0	18.3	31.6	12.0	100
32544	9.3-11.8	32.0	19.3	28.0	10.5	100
32545	15.8-19.5	42.0	25.0	37.0	12.5	100
32546	18.5-23.0	41.5	21.5	43.0	11.3	100

All products include a self-adhesive base.

SR 1788 Self-Adhesive Cable Clips Natural Nylon 66

- Strong adhesion for quick and easy installation
- Ideal for lightweight wire bundles
- Flammability rating UL94 V2

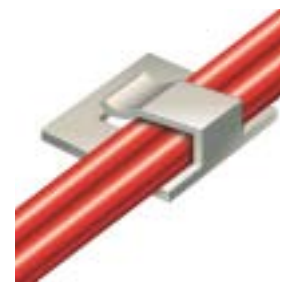

SR 1790 P Clips Natural Nylon 66

- Easy to install
- Ideal for holding cables, tubes and pipes
- Flammability rating UL94 V2
- Screw fixing hole diameter 4.6mm

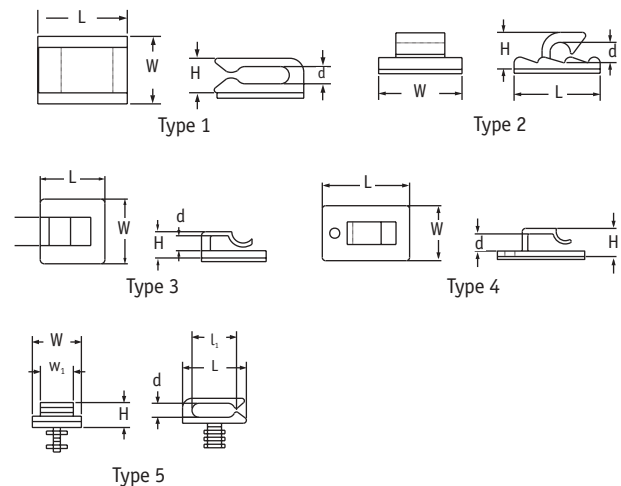
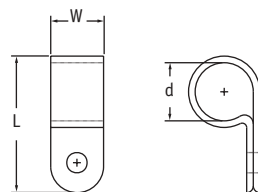

Part Number	Max Cable Dia (mm) d	Dimensions (mm)		Std Pack Qty
		L	W	
460275	3.2 (1/8")	19.8	9.6	100
460276	4.8 (3/16")	19.8	9.6	100
460277	6.35 (1/4")	22.0	10.0	100
460278	7.9 (5/16")	22.0	10.0	100
460279	9.5 (3/8")	24.0	12.0	100
460280	12.7 (1/2")	31.0	12.0	100
460281	15.8 (5/8")	34.3	12.0	100
460282	19.4 (3/4")	35.0	12.0	100
460283	25.4 (1")	43.0	12.0	100
460284	27.5 (1 1/16")	50.0	12.0	100
460285	31.8 (1 1/4")	46.2	12.0	100
460286	36.7 (1 1/2")	50.0	12.0	100

Part Number	Max Cable Dia (mm) d	Type	Dimensions (mm)					Std Pack Qty
			L	W	w ₁	l ₁	H	
460300	2.8	1	13.0	9.5	-	-	5.2	100
460301	4.8	2	16.0	15.5	-	-	6.8	100
460302	3.7	3	16.0	16.0	-	-	8.7	100
460303*	5.5	4	27.0	17.0	-	-	8.7	100
460304	5.8	1	16.0	15.8	-	-	9.0	100
460305	2.8	5	12.8	9.8	2.8	5.0	5.0	100

* Additional mounting hole of diameter 3.1mm.



Cable Clamps

SR 1789

Adhesive Cable Clamps

Adhesive and Screw Fixing Cable Clamp – Black Nylon 66

- Flammability rating UL94 V2
- Adhesive and/or screw fixing (dia 4.4mm)
- Backed with high-quality adhesive tape

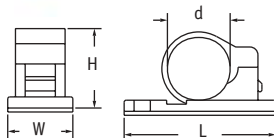

Part Number	Cable Diameter (mm) d	Dimensions (mm)			Std Pack Qty
		L	W	H	
460287	6.0	25.8	13.4	9.1	100
460288	9.0	29.4	13.4	14.0	100
460289	12.0	35.5	16.4	16.5	100
460290	14.0	36.5	16.4	18.5	100
460291	16.0	38.5	16.4	20.5	100
460292	18.0	42.0	16.4	22.5	100

Adhesive Cable Clamp – Grey Nylon 66

- Flammability rating UL94 V2
- Backed with high-quality adhesive tape

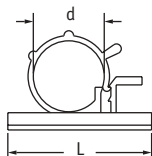
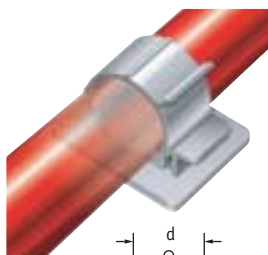

Part Number	Cable Diameter (mm) d	Dimensions (mm)	Std Pack Qty
		L	
460306	6-7	25.0	100
460307	7-8	25.0	100
460308	9-10	30.0	100
460309	12-14	30.0	100
460310	16-18	30.0	100

Adhesive Ribbon Cable Clip – Grey PVC

- Designed to clamp ribbon cable
- Flammability rating UL94 V2
- Backed with high-quality adhesive tape

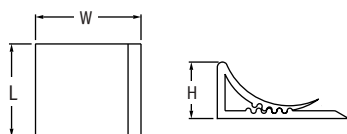
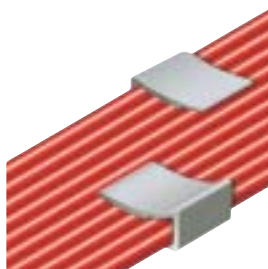

Part Number	Dimensions (mm)			Std Pack Qty
	L	W	H	
460293	15.0	25.0	10.0	100
460294	20.0	25.0	10.0	100
460295	25.0	25.0	10.0	100
460296	28.0	25.0	10.0	100

SR 1786

Push-In Cable Clamps

Grey Nylon 66

- Easy one-push fit
- One size fits a range of cable diameters
- Flammability rating UL94 V2
- One standard panel hole diameter of 4.8mm

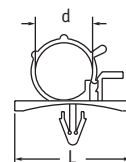

Part Number	Cable Diameter (mm) d	Dimensions (mm)	Std Pack Qty
		L	
460311	6-7	25.0	100
460312	7-8	25.0	100
460313	9-10	30.0	100
460314	12-14	30.0	100
460315	16-18	30.0	100

SR 1787

Adjustable Cable Clamps

Natural Nylon 66

- Strong adhesion for quick and easy installation
- Flammability rating UL94 V2

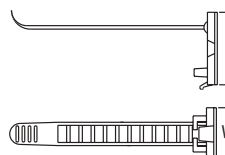

Part Number	Max Cable Diameter (mm)	Dimensions (mm)		Std Pack Qty
		L	W	
460297	17.0	25.0	18.0	100
460298	22.0	30.5	21.0	100
460299	26.0	30.5	21.0	100

Try it! Free sample service



If you would like a sample of any of our products to evaluate suitability before you order, please call us, or visit our website www.mossplastics.com to order direct.



SR 1783 Push-In Wire Saddles

Natural Nylon 66

- Easy one-push fit
- One size fits a range of cable diameters
- Choice of four styles
- Flammability rating UL94 V2



Type 1

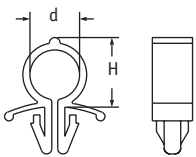

- Permanent retention of cable close to fixing point

Type 3

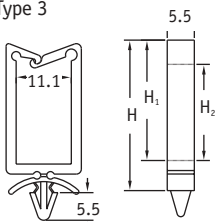

- Range of sizes to accommodate a number of cables or cable sizes

Type 1 (Omega Clip)

Part Number	Dimensions (mm)		Std Pack Qty
	d	H	
460319	6.35	8.8	100

Fits 5.4mm panel hole.

Type 2 (Locking Wire Saddle)

Part Number	d	Dimensions (mm)			Std Pack Qty
		H ₁	H ₂	W	
460320	15.0	22.0	21.2	14.8	100

Fits 4.5mm panel hole.

Type 3 (Square/Rectangular Locking Wire Saddle)

Part Number	Dimensions (mm)			Std Pack Qty
	H	H ₁	H ₂	
460321	12.7	9.2	2.8	100
460322	17.9	14.4	8.6	100
460323	26.9	23.4	18.2	100
460324	18.0	15.7	12.5	100
460325	34.8	31.3	26.2	100

All sizes fit 4.8mm panel hole.

Type 4 (Double Routing)

Part Number	Dimensions (mm)		Std Pack Qty
	d	H	
460326	6.2	7.7	100

Fits 3.2mm panel hole.

Type 2

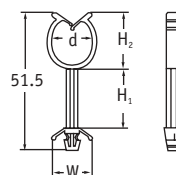

- Enables stand-off from surface where components are present

Type 4

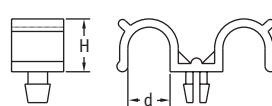

- Enables parallel runs of cables close to fixing point

SR 1784 Adhesive Wire Saddles

Natural Nylon 66

- Strong adhesion for quick and easy installation
- One size fits a range of cable diameters
- Flammability rating UL94 V2

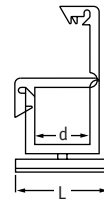

Type 1

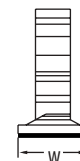

Type 2

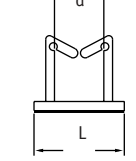

Type 3

Part Number	Type	Dimensions (mm)			Std Pack Qty
		d	W	L	
460316	1	11.2	19.8	20.0	100
460317	2	8.5	16.0	29.8	100
460318	3	11.3	18.3	20.7	100



Let us help you

If you are unsure about a product's suitability for your needs, or need to know more about its specification or performance than is provided in our catalogue, then please call us.



Terminal Sleeves

SR 1771

Terminal Sleeves

PVC

- Protect wiring terminal
- Widely used in automotive and electrical industries

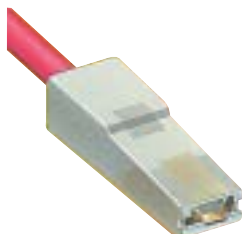
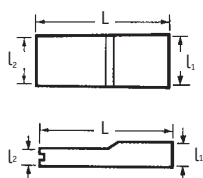

Post-Fit Straight Type, Clear PVC

Part Number	Terminal Size (mm)	Dimensions (mm)			Std Pack Qty
		L ₁	L	L ₂	
10177	4.8	6.3 x 2.8	23.0	4.5 x 1.5	20000
10077	6.3	7.8 x 3.2	26.5	6.0 x 1.5	10000

Many other sizes available; please contact our sales office for more details.

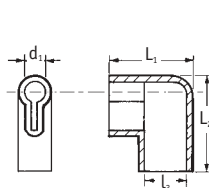

Post-Fit Right-Angled Type, Clear PVC

- This design can be fitted after the terminal is crimped to the wire

Part Number	Terminal Size (mm)	d ₁	Dimensions (mm)			Std Pack Qty
			L ₁	L ₃	L ₂	
10100	4.8	4.0	15.0	6.0 x 3.0	15.0	20000
10145	6.3	4.0	16.5	8.5 x 4.0	18.5	10000

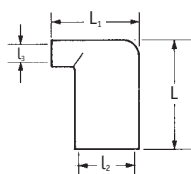

Standard Right-Angled Type, Clear PVC

Part Number	Terminal Size (mm)	Dimensions (mm)				Std Pack Qty
		L ₃	L	L ₂	L ₁	
10262	4.8	4.6 x 2.8	12.3	6.2 x 2.1	12.3	30000
10622	6.3	3.0	16.0	8.3 x 3.1	14.4	20000
10234	9.5	4.3	23.7	12.0 x 4.8	24.0	10000
10623	6.3	4.5	17.0	8.8 x 3.0	14.3	20000



Standard Straight Type, Black or Clear PVC

Part Number	Clear PVC	Black PVC	Terminal Size (mm)	Dimensions (mm)			Std Pack Qty
				L ₁	L	L ₂	
10545*	—	—	2.8	2.8	23.3	4.3 x 2.8	30000
11603	—	19774	2.8	2.5	19.5	3.7 x 2.5	20000
10973	—	—	9.5	3.3	32.9	11.0 x 3.2	10000
10631	—	—	9.5	4.8	33.4	10.3 x 4.0	5000
10490	—	800920	4.8	2.8	25.4	7.4 x 2.0	20000
11049	—	51841	4.8	3.0	19.0	4.8 x 1.7	20000
10229	—	50445	4.8	3.0	29.3	7.5 x 2.0	20000
10789	—	50544	6.3	4.0 x 2.5	26.4	7.7 x 2.3	20000
50760	—	51957	6.3	4.3 x 2.0	26.0	7.5 x 2.0	20000
10626	—	50164	6.3	5.7 x 2.3	27.0	7.6 x 2.3	10000

* Natural nylon.

SR 1773

IEC Standard Terminal Insulation Sleeves

Black Flexible PVC

- Protect and insulate rear connection receptacles of IEC standard inlets and outlets
- Flash tested to 3K Volts AC (EN 60950)
- 'V' rated in accordance with UL94

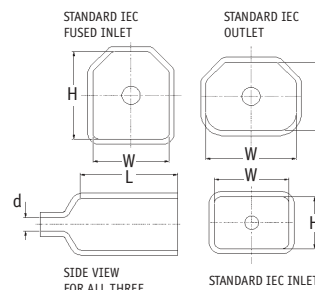

Part Number	Description	Dimensions (mm)				Std Pack Qty
		H	W	L	d	
TSWXA-01	Fused Inlet	31.5	26.5	45.0	6.4	400
TSWXA-02	Standard Outlet	24.0	31.5	45.0	6.4	400
TSWXA-03	Standard Inlet	18.2	26.1	33.0	4.8	400

Visit our Website

- Product information
- Literature and product samples
- Range review

www.mossplastics.com

